

eduard
MASK

Ki-49 Helen 1/72

The die-cut mask for accurate canopy frame painting of the
Hasegawa scale 1/72 KIT

CX 097

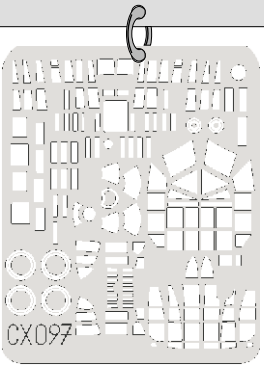

J 9

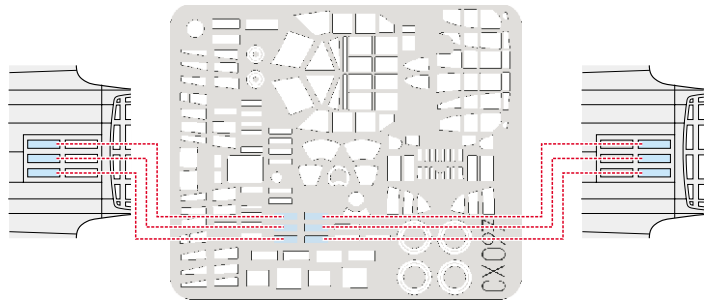

J 3

1.)

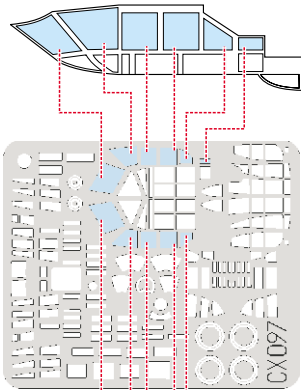

2.)

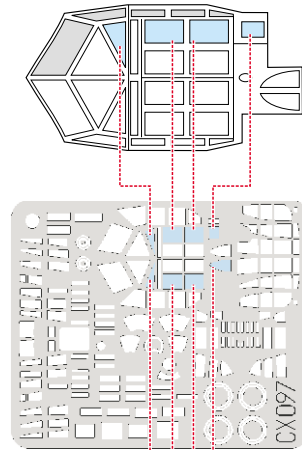

3.)

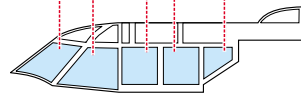

4.)

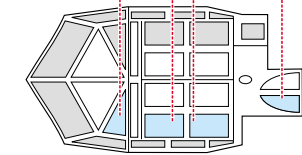

J 3

5.)

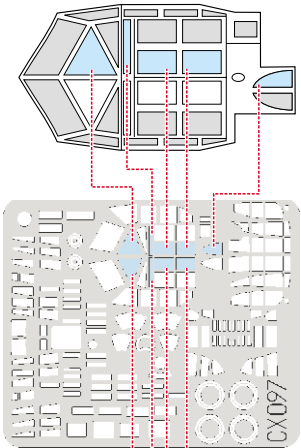

J 5

J 4

J 20

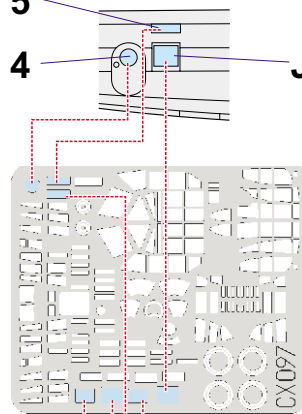

6.)

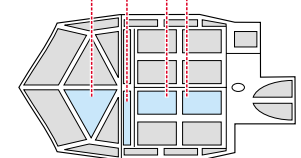

J 19

J 6

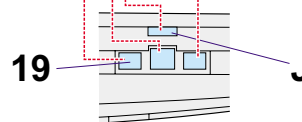

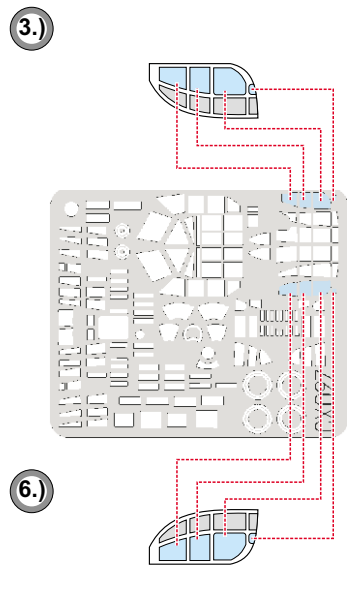
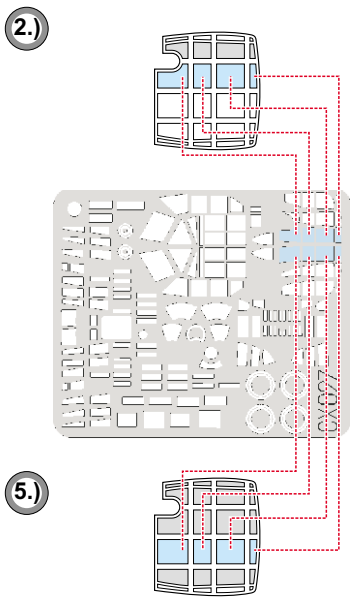
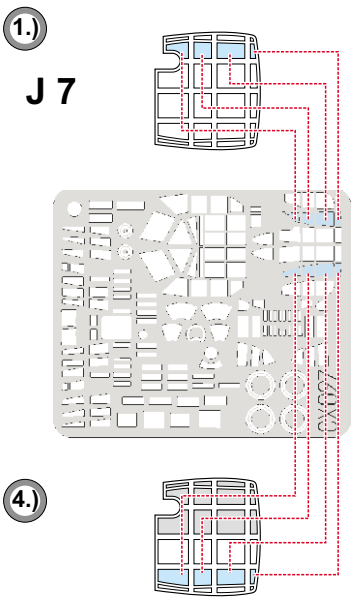
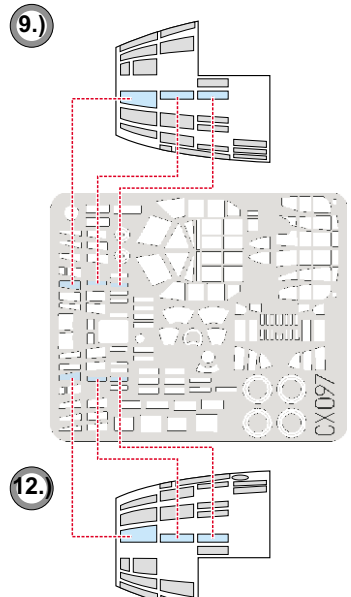
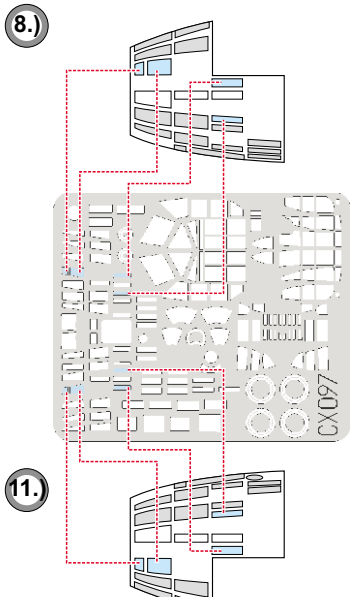
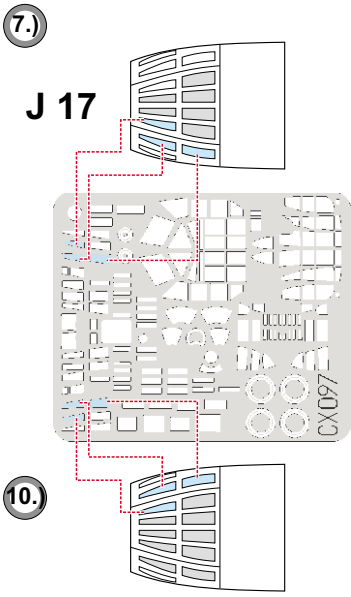
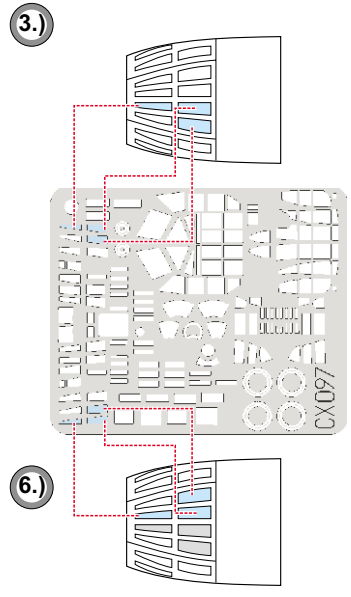
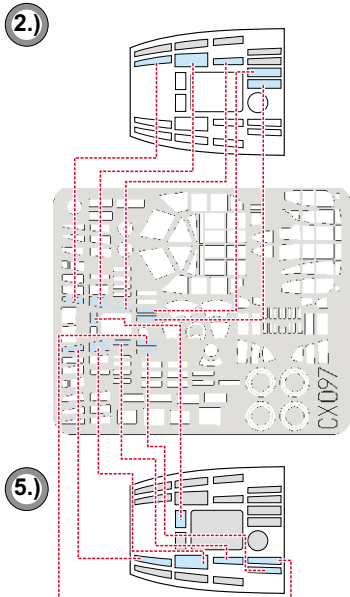
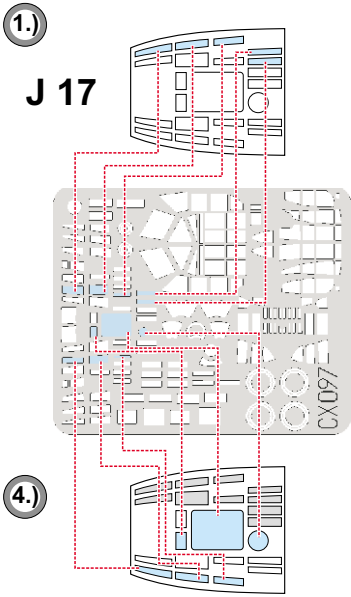

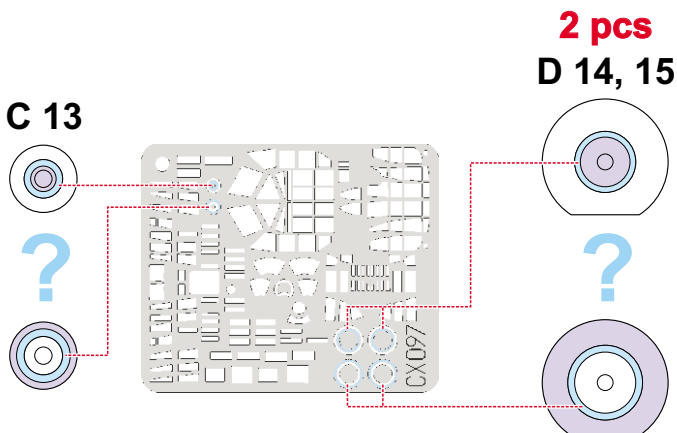
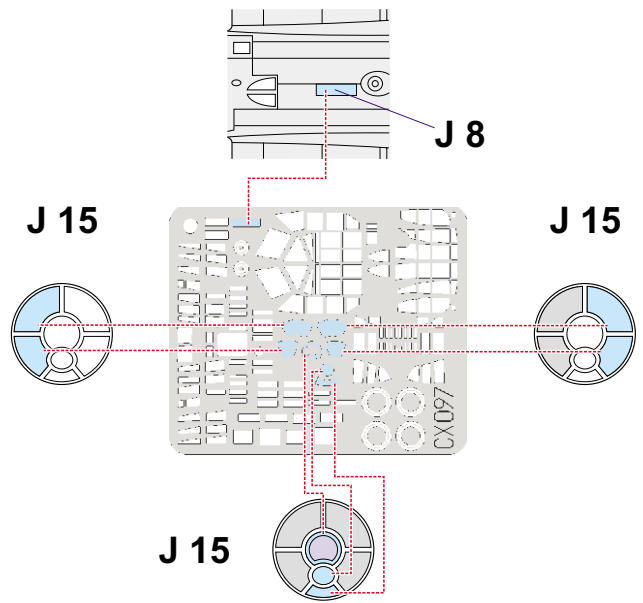
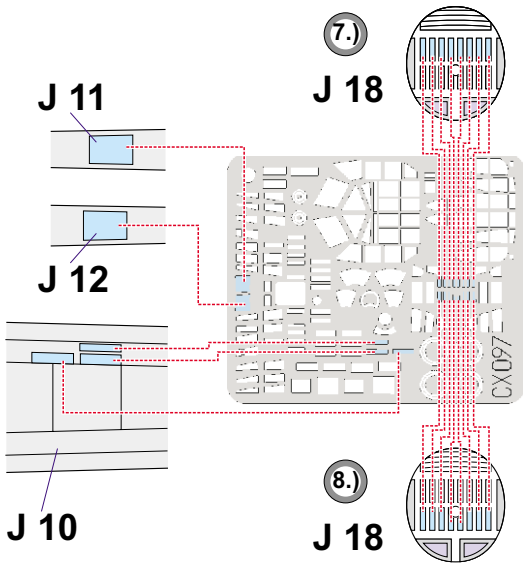
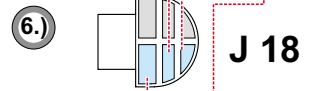
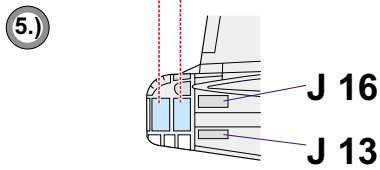
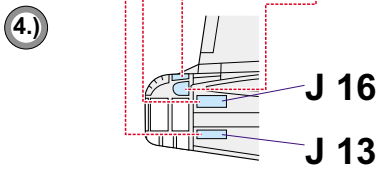
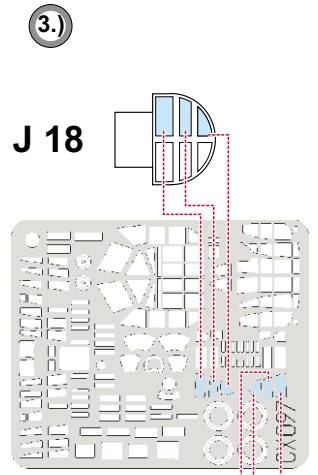
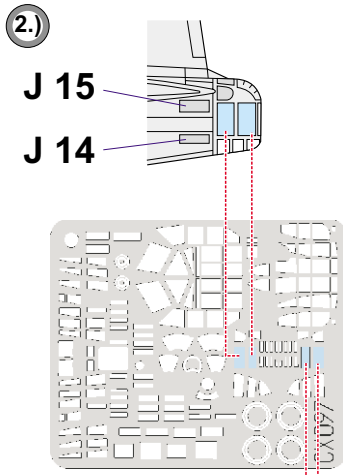
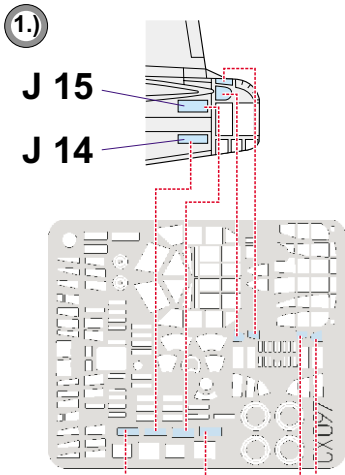

REFERENCES:

Nakajima Ki-49 DONRYU in JAAF Service
Richard M. Bueschel