

648 563 GBU-31(V)3B JDAM

eduard
BRASSIN

1/48 scale

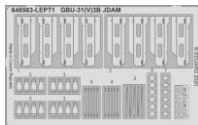
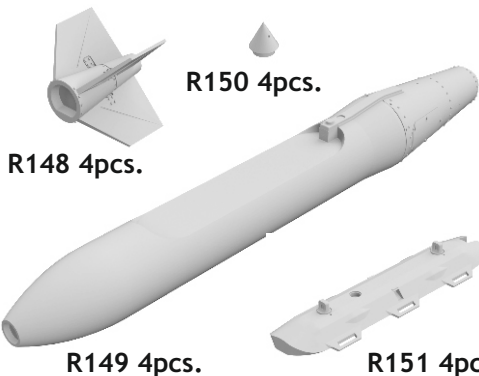

COLOURS

GSI Creos (GUNZE)		Mr.COLOR SUPER METALLIC	
AQUEOUS	Mr.COLOR		
H 8	C 8	SM205	SUPER TITANIUM
H52	C12		
H305	C305		
H308	C308		

This product contains metal and resin detail parts for upgrading scale plastic models. When selecting this set make sure that it is for the kit mentioned in product name as these sets are made specifically for that kit. When upgrading the model some cutting or corrections may be necessary for parts to fit accurately. **WARNING!** This set contains small and sharp parts. Work carefully in a ventilated and well-lit room. Safety glasses are recommended. This product is not suitable for children below 14 years of age.

Tento výrobek obsahuje leptané a odlévané detaily pro úpravu a vylepšení plastického modelu. Při výběru sady kovových detailů zkontrolujte, zda je určena pro model, který chcete upravit. Model, pro který je sada určena, je uveden u názvu výrobku. Pro přesnou aplikaci kovových a odlévaných dílů může být zapotřebí upravit díly upravovaného modelu. **POZOR!** Sada obsahuje malé ostré díly. Pracujte ve větrané a dobře osvětlené místnosti. Doporučujeme použití ochranných brýlí. Tento výrobek není vhodný pro děti mladší 14 let.

eduard

www.eduard.com
14,95

435 21 Obrnice 170
Czech Republic



648 563 GBU-31(V)3B JDAM

1/48

BRASSIN

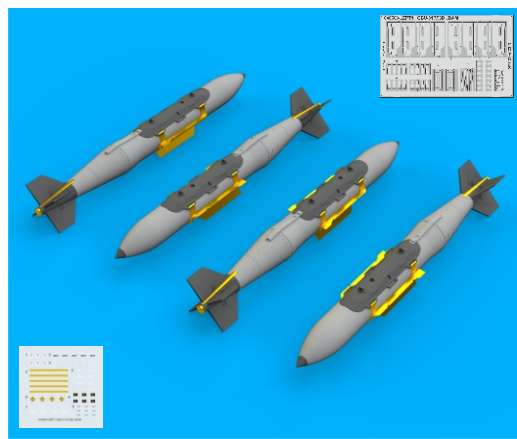

BRASSIN

eduard

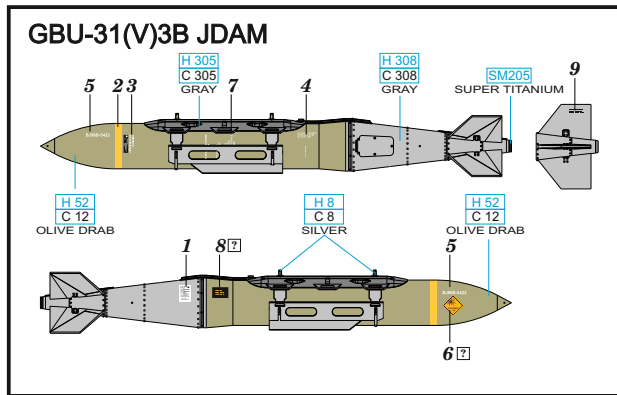

BEST BRASS RESIN AROUND!



R151

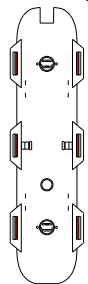



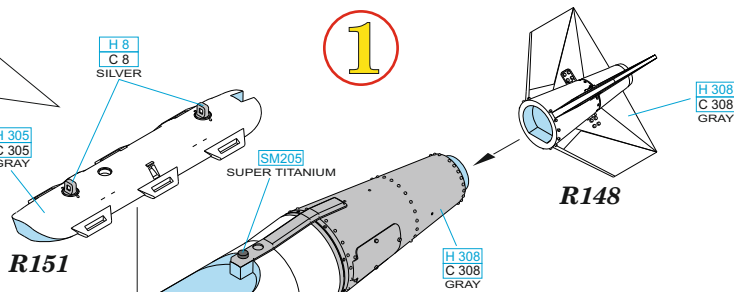



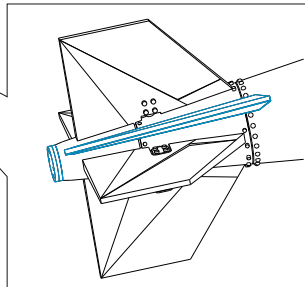
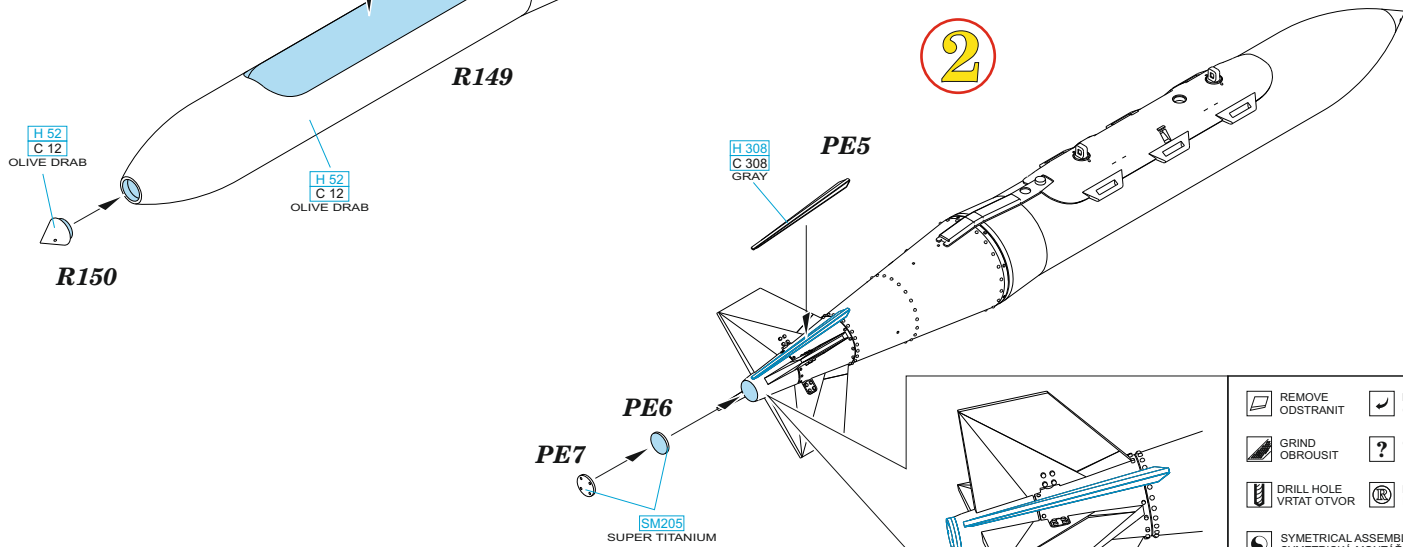

1



2



-  REMOVE ODSTRANIT
-  GRIND OBROUSIT
-  DRILL HOLE VRTAT OTVOR
-  SYMMETRICAL ASSEMBLY SYMETRICKA MONTAZ
-  SCRIBE THE PANEL AND HOLES RYTI
-  REVERSE SIDE OTOCIT
-  BEND OHNOUT
-  OPTION VOLBA
-  REPLACE NAHRADIT

3

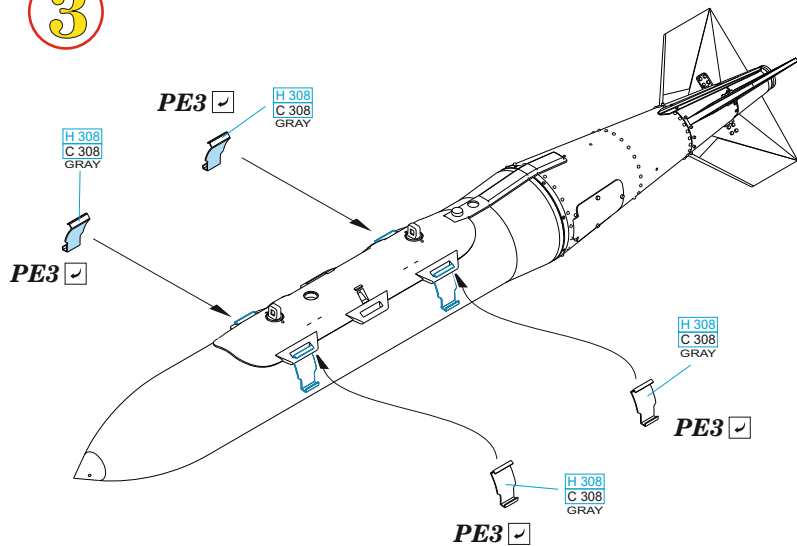

4



PE3

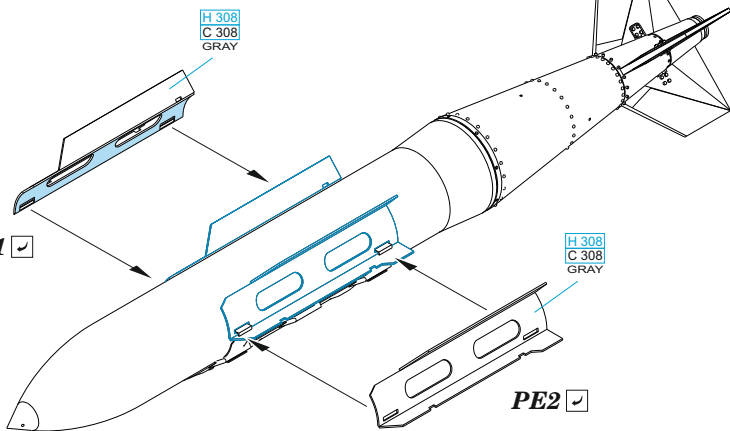

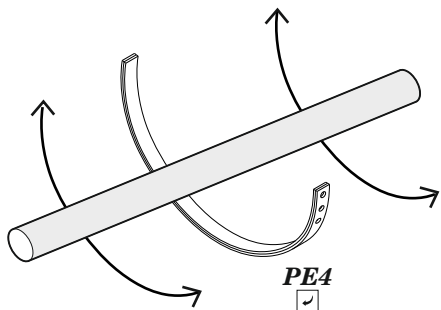

5

